

SERIES SU STEEL FRAMES (UNEQUAL RABBET)

FOR 1-3/4" THICK DOORS
STANDARD WALL APPLICATION, HANDED

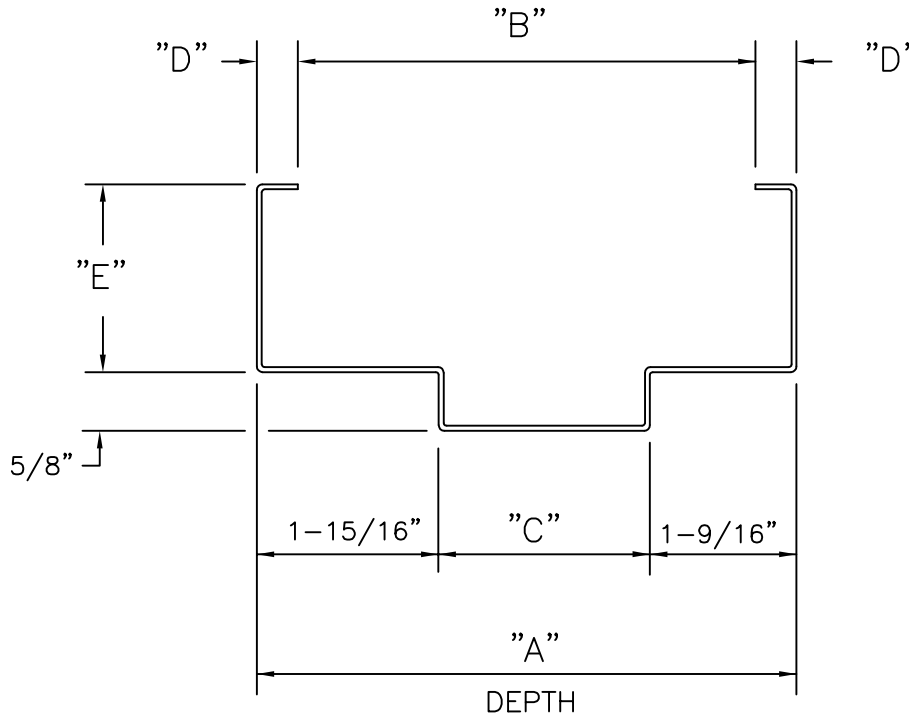

(Conversion: 1" = 25.4 mm, e.g., 1-3/4" = 44.45 mm)

DEPTH	A	B	C	D	E	
					HEAD & JAMBS	HEAD & JAMBS
434	4-3/4"	3-3/4"	1-1/4"	1/2"	2"	1"
534	5-3/4"	4-7/8"	2-1/4"	7/16"	2"	1"
634	6-3/4"	5-3/4"	3-1/4"	1/2"	2"	1"
734	7-3/4"	6-3/4"	4-1/4"	1/2"	2"	1"
834	8-3/4"	7-3/4"	5-1/4"	1/2"	2"	1"

Series SU, double rabbet frames (with unequal rabbets) are also available in a range of depths from: 4-5/8" thru 14" in 1/8" increments.
4" face heads with 2" face jambs are also available in selected sizes.

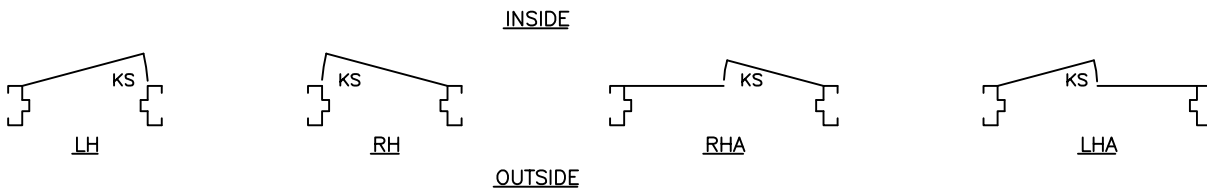

"KS" = KEY SIDE

F1-2

Hardware locations shown match Ceco standard doors.

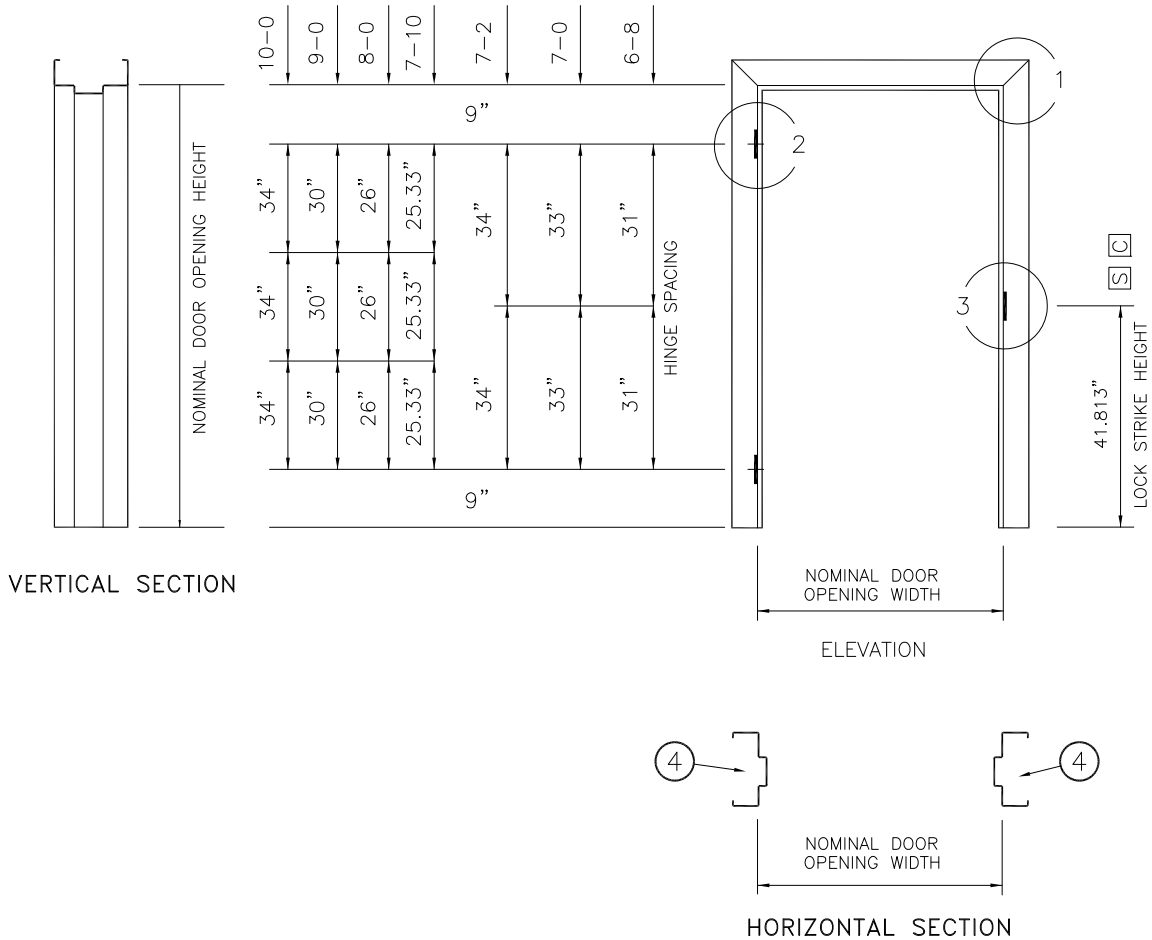

(Conversion: 1" = 25.4 mm, e.g., 1-3/4" = 44.45 mm)

<p>JAMB ANCHOR QUANTITIES</p>	<p>2 PER JAMB FOR HEIGHTS 3/6 THRU 5/0 AND ONE FLOOR ANCHOR 3 PER JAMB FOR HEIGHTS >5/0 THRU 7/2 AND ONE FLOOR ANCHOR 4 PER JAMB FOR HEIGHTS >7/2 THRU 7/6 AND ONE FLOOR ANCHOR 5 PER JAMB FOR HEIGHTS >7/6 THRU 10/0 AND ONE FLOOR ANCHOR ONE ADDITIONAL JAMB ANCHOR FOR EACH ADDITIONAL TWO FEET IN HEIGHT OR FRACTION THEREOF ONE ADDITIONAL JAMB ANCHOR IN LIEU OF FLOOR ANCHOR FOR EXISTING STUDS AND/OR WALL CONDITIONS.</p>		
<p>WIRE MASONRY ANCHOR WMA</p> <p>7 GA. GALV. STEEL SNAP-IN TYPE</p>	<p>MASONRY "T" ANCHOR (ADJUSTABLE) MT</p> <p>ADJUSTS TO FIT 3-3/4", 4-1/4", 4-3/4", 5-1/4" & 5-3/4".</p> <p>2"</p>	<p>EXISTING OPENING ANCHOR EO</p> <p>SNAP-IN ANCHOR</p> <p>2"</p> <p>SU PROFILE EO/S6: 4-3/4" THRU 6-3/4" DEPTH EO/S8: 6-7/8" THRU 8-3/4" DEPTH</p>	

(For 3" THRU 8-3/4" DEPTHS)

ALTERNATE MT ANCHOR DESIGN IS AVAILABLE FOR SPECIAL DEPTH & FACE FRAMES. SEE SECTION F13 FOR DETAILS.

02/13/18

FI-3

① KNOCKED DOWN (KD) CORNER CONSTRUCTION

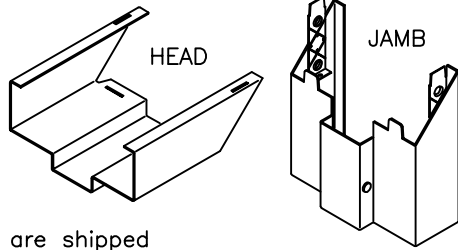

Components are shipped "knocked down" and assembled at the job site

① WELDED CORNERS

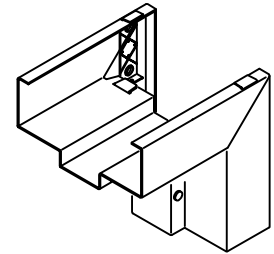

Die-cut corner with corner tab and face weld shown. Also available without tab and welded or mitre sawed and welded. Alternative weld options are also available.

② HINGE PREPARATION

4-1/2" x .134" OR
4-1/2" x .180"
ANSI A156.7 TEMPLATE
7 GAGE STEEL
REINFORCING

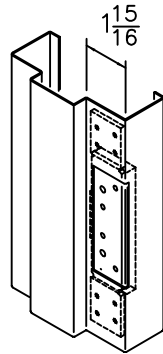

BACKSET: 5/16"

② HINGE PREPARATION

5" x .146" OR
5" x .190"
ANSI A156.7 TEMPLATE
7 GAGE STEEL
REINFORCING

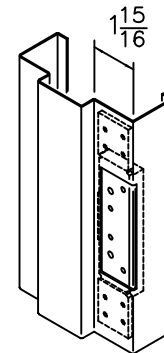

BACKSET: 5/16"

(Conversion: 1" = 25.4 mm, e.g., 1-3/4" = 44.45 mm)

③ LOCK STRIKE PREPARATION



UNIVERSAL (4-7/8")
ANSI A115.1 & 2 TEMPLATE
16 GAGE STEEL REINFORCING
WITH EXTRUDED SCREW HOLES
PROVIDES EQUIVALENT THREAD
ENGAGEMENT EQUAL TO 14 GAGE.
STANDARD FOR 1-3/4" DOORS

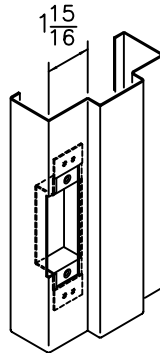

③ LOCK STRIKE PREPARATION



CYLINDRICAL (2-3/4")
ANSI A115.2 TEMPLATE
16 GAGE STEEL REINFORCING
WITH EXTRUDED SCREW HOLES
PROVIDES EQUIVALENT THREAD
ENGAGEMENT EQUAL TO 14 GAGE.
OPTIONAL FOR 1-3/4" DOORS

ALSO AVAILABLE WITHOUT LIP
NOTCH FOR DEADBOLTS.

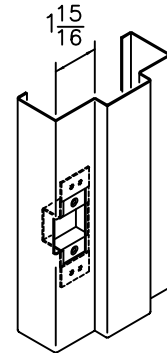

④ WOOD STUD ANCHOR WS

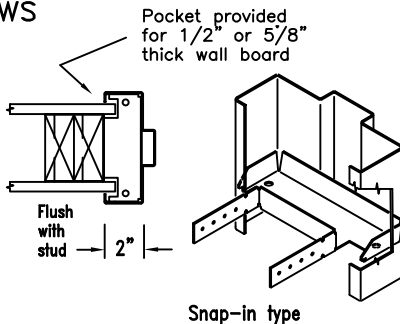

(Used also for METAL STUD Walls)

④ METAL STUD ANCHOR MS

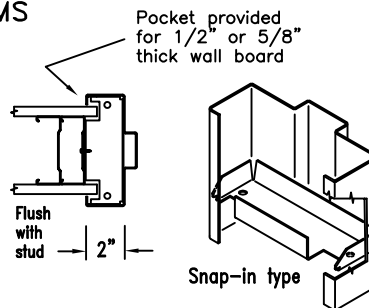

4-3/4" and 5-3/4" Depth Only
For other depths use WS type.

④ FIXED FLOOR ANCHOR SA

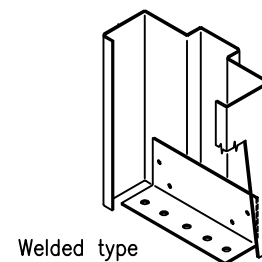

ONE PIECE

06/24/11

F1-4

STANDARD SIZES NOMINAL DOOR OPENING

WIDTH		HEIGHT
SINGLE	DOUBLE	
2'-0"	4'-0"	6'-8" 7'-0" 7'-2" 7'-10" 8'-0" 9'-0" 10'-0"
2'-4"	4'-8"	
2'-6"	5'-0"	
2'-8"	5'-4"	
2'-10"	5'-8"	
3'-0"	6'-0"	
3'-4"	6'-8"	
3'-6"	7'-0"	
3'-8"	7'-4"	
3'-10"	7'-8"	
4'-0"	8'-0"	
5'-0"	10'-0"	

PRODUCT SPECIFICATIONS:

Steel door frames shall be as manufactured by Ceco Door Products, Milan, TN or Mason City, IA USA. They shall conform to the Steel Door Institute guide specification, ANSI A250.8. See chart below for performance classifications.

Series SU frames for 1-3/4" doors are formed from commercial quality cold rolled steel conforming to ASTM A1008 ...or (optional) hot-dipped galvanized steel conforming to ASTM A924 and A653 - see chart below.

Frames are knocked down (K.D.) field assembled type or welded unit type. Head and jamb members of K.D. frames have diecut mitered corners that interlock rigidly when field assembled. Integral door stops are 5/8" high. Jambs are sized to suit wall applications. Twist-in anchors are available for new masonry, wood stud, metal stud, or existing opening wall conditions (indicate which). Floor anchors or extra jamb anchors are provided to anchor sill. Welded-in jamb anchors are also available.

FIRE DOORS

LABELING AGENCIES:

- UNDERWRITERS LABORATORY
- WARNOCK HERSEY
- FACTORY MUTUAL

TEST: UL10B, UL10C, U11784 & NFPA 252

- RATING: 20 MIN, 3/4 HR, 1 HR, 1-1/2 HR, OR 3 HR
- MAX. SIZE: 40 x 100 SINGLE
80 x 100 PAIR

Not all ratings are available in all sizes, designs and materials. Hourly classifications are not shown on label unless class is less than 3 hours.

Hardware Provisions: Frames are handed. Hinge jambs are mortised for 4-1/2" or 5" high, standard and heavy weight hinges (specify which). 7 gage steel reinforcements are welded in place and are drilled and tapped for fasteners in accordance with ANSI A156.7. The strike jamb is prepared for 4-7/8" universal or 2-3/4" cylindrical strike in accordance with ANSI A 115.1 & 2 (specify which). Plaster guards are provided. Optional closer reinforcement is a 14 gage steel formed steel sleeve (12 gage upon request). 3 mute holes are provided per strike jamb and 2 for double swing heads.

Paint: Steel door frames are provided with one coat of oven-cured neutral color primer paint. Primer coat shall conform with ANSI A250.10. The primer coat is a preparatory base for necessary finish painting. "Colorstyle" finish coat is also available on K.D. frames from a selection of standard colors (optional). Colorstyle finish is electrostatically applied, oven-cured urethane enamel, and shall conform to ANSI A250.3. For accurate color selectors ask for a Ceco Colorstyle chart.

MATERIAL

DOOR FRAME MATERIAL	LEVEL	C.R.	GALV	
			A60	G90
16 Gage Steel	Heavy or Extra Heavy Duty	STD	OPT	OPT
14 Gage Steel	Maximun Duty	STD	OPT	OPT

(Conversion: 1" = 25.4 mm, e.g., 1-3/4" = 44.45 mm)

PERFORMANCE

Physical Endurance Level:	Meets ANSI A250.4 Performance Test -- 16 & 14 gage steel: Level A (1,000,000 Cycles)
---------------------------	--

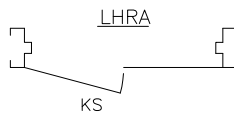
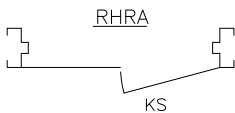

INSIDE

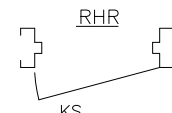
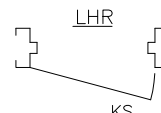

OUTSIDE

"SUFFIX"A" = ACTIVE LEAF OF PAIRS

"KS" = KEY SIDE

Ceco Door

ASSA ABLOY

05/03/17